

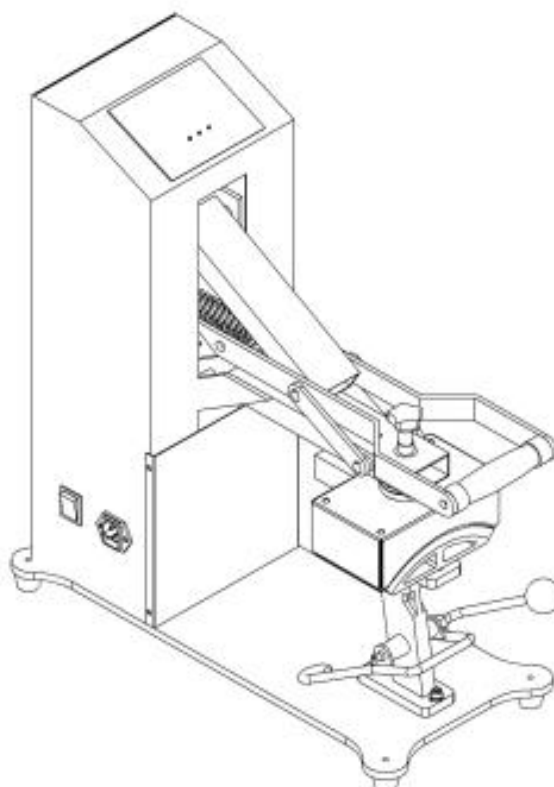

# Arkipress DCap Prensa manual para gorras

**Model No.: DCP-100B**



## CONTENTS

I. Assembly Drawing	2
II. Technical Parameters	2
III. Operation Process	3-4
IV. Maintenance	4
V. Trouble Shooting For Transfer Print Quality	5
VI. Circuit Diagram	6
VII. Explosion View	7-8

## I. Assembly Drawing

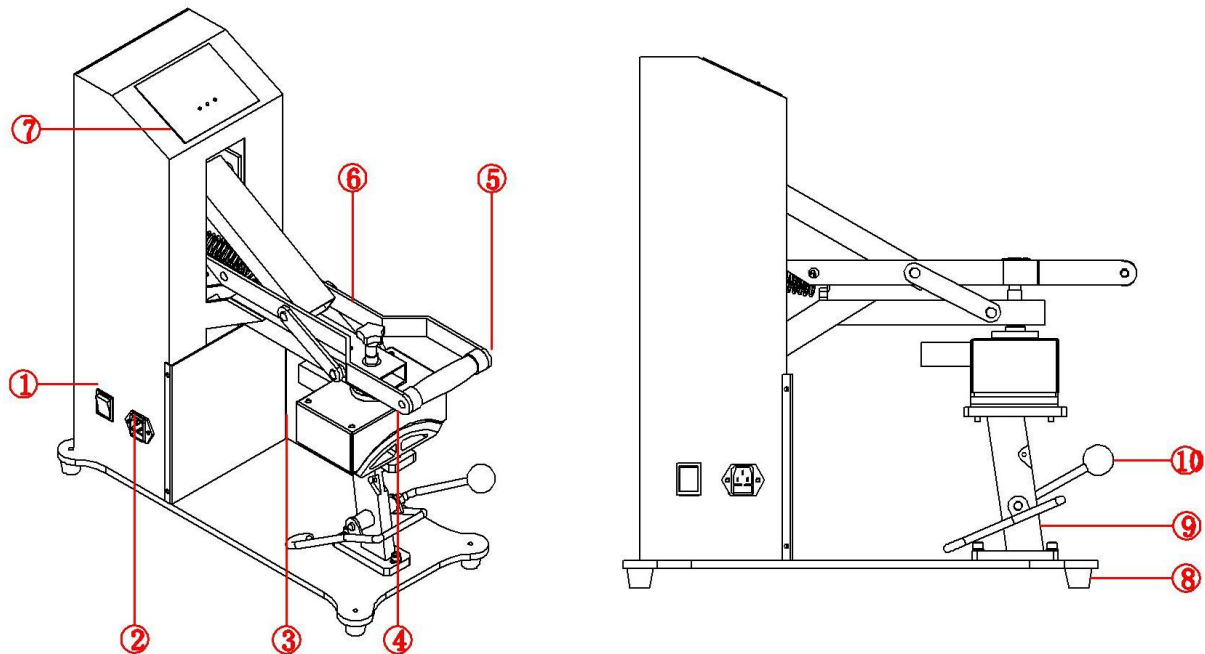









- |                   |                |                      |                   |
|-------------------|----------------|----------------------|-------------------|
| ① Power Switch    | ② Power Socket | ③ Cap Heater         | ④ Cap Under Plate |
| ⑤ Handle Bar Grip | ⑥ Handle Frame | ⑦ Digital Controller | ⑧ Rubber Foot     |
| ⑨ Support Plate   | ⑩ Hat Rack     |                      |                   |

## II. Technical Parameters

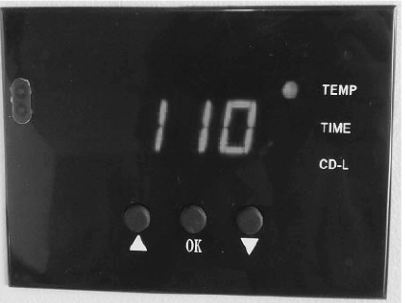





1. Model No.: DCP-100B
2. Machine Dimension: 525\*540\*225mm
3. Cap Heater Size: for normal caps
4. Printable Articles Max Size: 80\*130\*10mm
5. Voltage: 220V/1Phase; 110V/1Phase
6. Power: 0.5KW
7. Recommend Setting: 30~280s; 180~200°C  
Time Range: 0~999s  
Maximum Temp: 225 C°
8. Packing Size: 70\*66\*33cm
9. Gross Weight: 18.3kg

## III. Operating Process

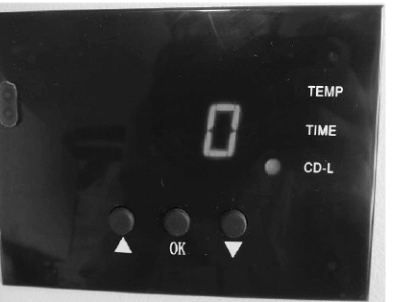
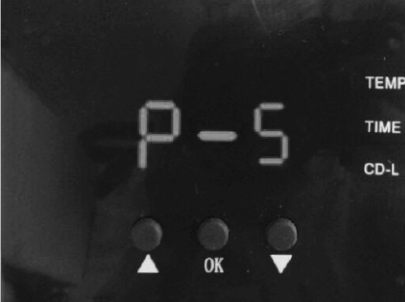
### 1. Set temperature required

		
<p>Turn on power switch, temperature light is ON. The digital display shows</p> 	<p>Press  button, the  light is on (C denotes Celsius). Press arrows “△” or “▽” to select “°C” or “°F” (F denotes Fahrenheit) according to your habits.</p>	<p>Press  button, the temp  light is ON. Press Up “△” or Down “▽” button to set temperature according to different transfer material. (Normally 180° ~200° )</p> <p><b>Note:</b> Temperature will be shown on the controller only after it reached to <b>100°</b> , it's normal that there is no temperature shows right after the setting.</p>

### 2. Set time required

		
<p>Press  button after the temperature setting and the  time light is ON. Press Up “△” or Down “▽” button to set time according to different transfer material.</p>	<p>Press  button after time setting; the display shows the temperature starts to rise. “CD-L” shows the time counting down during your transfer.</p>	<p>If there is a difference between the actual temperature and temperature shows on the controller, you can use <b>P5 mode</b> to calibrate the difference.</p> <p>For example, when actual heat platen temperature is 180 °C but the display shows 200°C, press  button for 5 seconds to enter the P5 mode. When enter P5 mode, press UP button “△” to set to 20, and then press  button again for 5 seconds return to operation mode. In the contrast, when actual</p>

		heat platen temperature is 200 °C but the display shows 180°C, press Down button “▽” to set to -20, and then press  button 5 seconds return to operation mode
--	--	--

### 3. Printing methods

Step 1: Make sure the cord is connected well to the wall socket. Place the cap in the cap heater, and transfer paper with images facing down the cap, adjust moderate pressure, and power on.

P.S: use heat resistant tape to fix the transfer paper, make sure transfer paper is exactly attached to cap heater;

Step 2: Set the temperature and time required, then temperature starts to rise.

Step 3: When the temperature rises to the setting temperature, the buzzer sends out sounds; then press down the cap heater, (meantime the sounds stop) and starts to transfer.

Step 4: Then the time counter is on, once time is up, take out the caps. Transfer work finished.

### 5. Recommendations:

Cap transfer: Set temperature: 180°C. Set time: 60 seconds

## V. Maintenance

### 1. No action after turn on the machine

- 1). Check the plug whether it connects well or whether it is broken.
- 2). Check the power switch or digital controller whether it is broken.
- 3). Check the fuse whether it has been burnt out.
- 4). Indicating light is on, but no display on screen, check the 5 cable of Railway transformer. If it's loosening, showing the problem is poor connection. If they connects well, showing that the Transformer is faulty.

### 2. The display screen are working well, but no temperature increasing on the cap heater.

- 1). Check whether the thermocouple of the cap heater touches well. If the thermocouple is loose, the display will show 255°C. and machine keeps beeping.
- 2). Check if the indicating light of solid-state relay is on, if not, check if the relay or digital controller is broken.
- 3). If you already changed the new solid-state relay but the cap heater still can't heating up, check if the cap heater is faulty or the cap heater's power cable is loose, need to change by new cap heater.

### 3. The display screen show 255☒ once you power on.

- 1). Check whether the thermocouple is loose or not.
- 2). If the thermocouple touches is not in loose state, but still show 255☒ , then it is faulty.

### 4. The machine is heating during 0~180°C, but display number jumps to above 200°C or 300°C suddenly, or the numbers on display jumps irregularly.

- 1). Check whether the thermocouple of the cap heater touches well.
- 2). If the thermocouple is good, It shows that the program of digital controller is broken, which namely IC or is broken, need to change by new controller.

### 5. The temperature is out of control: Set 180☒ , but the actual temperature is above 200☒ 。

- 1). It means the solid-state relay is broken, out of control, need to change the relay.
- 2). Or the digital controller is faulty and it keeps conveying electric to relay, need to change controller.

**6. The setting temp and time becomes abnormal after exchange the cap heater.**

1). Please reset the temp and time according the operation process manual.

**7. Other notice**

1). In order to prolong the machine service life, please add the lubrication oil regularly on the joints.

2). In order to keep the cap heater's good transfer effect, pls protect it carefully whenever you are using or not.

3). Please keep the machine in dry place.

4). If you are not able to solve the electrical parts problem, please kindly contact the supplier and get technical support.

## **IV. Trouble shooting for transfer print quality**

1. If the print color is pale: the temperature is too low / the pressure is not correct / or not pressed long enough.

2. If the print color is too brown or the transfer paper is almost burnt: reduce the setting temperature.

2. If the print is blurring: too much transfer time causes proliferation.

3. If print color is different/ partial transfer effect is not good enough: the pressure is not enough / or not pressed long enough / or poor quality transfer paper.

4. If transfer paper stick to the object after transfer: the temperature is too high/ or poor quality printing ink.

# VI. Circuit Diagram

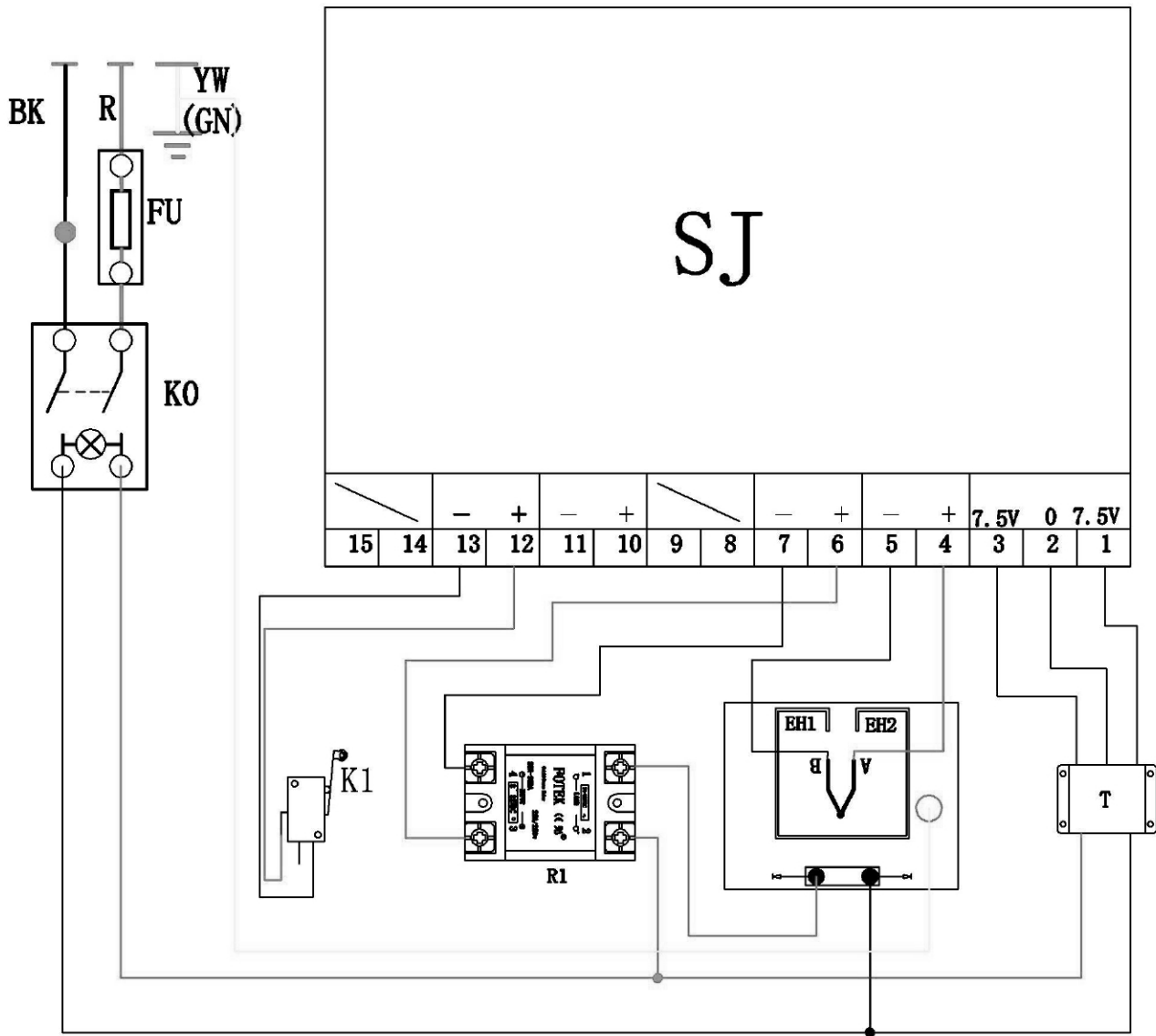

K0: Power Switch  
T: Transformer

SJ: Digital Controller  
R1:Relay

FU:Fuse

EH<sub>1</sub>EH<sub>2</sub>:Heating Pipe

## VII. Explosion View

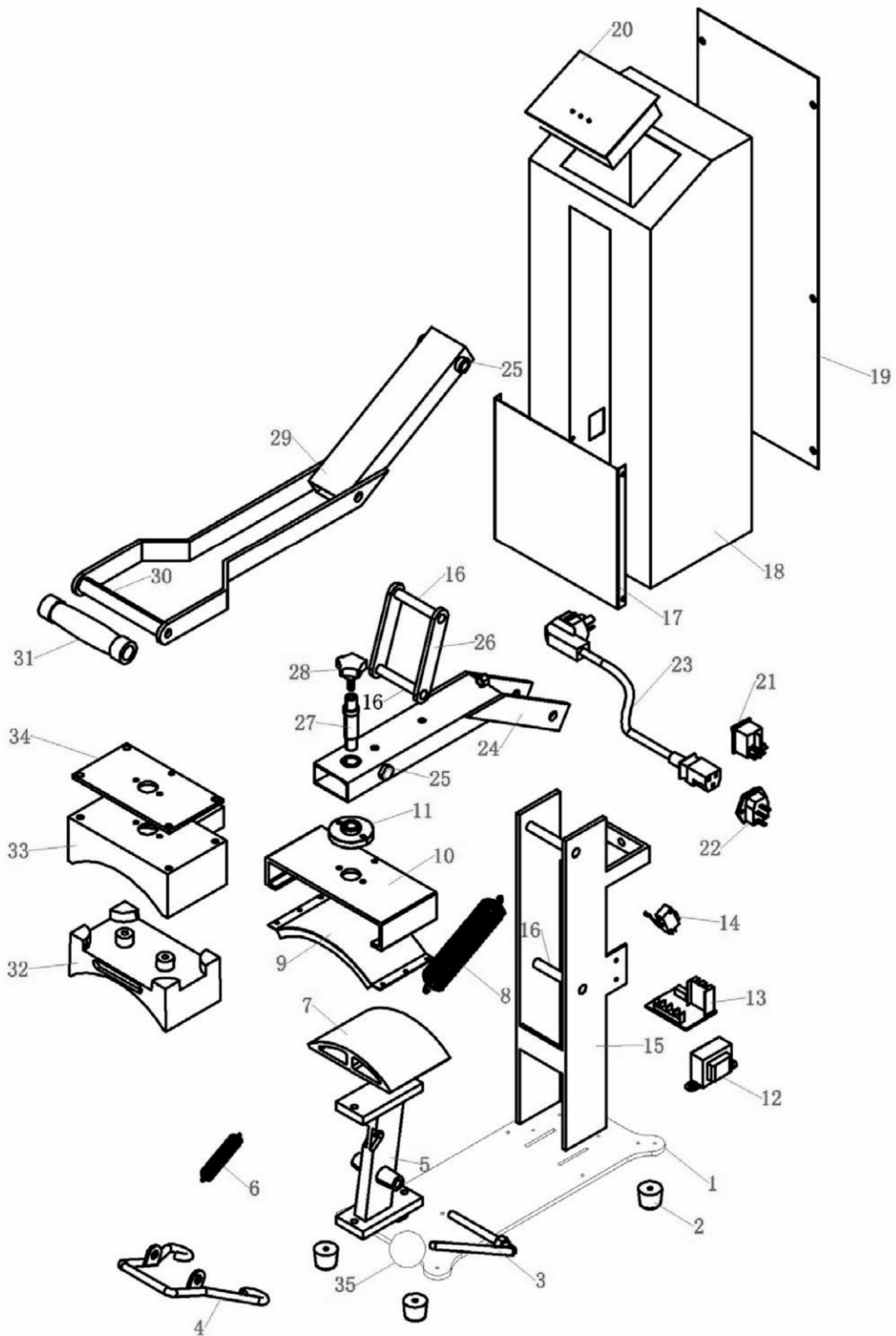

Serial No.	Part Name	Qty
1	Machine Base	1
2	Rubber Foot	4
3	Cap Rack Handle	1
4	Cap Rack	1
5	Support Plate	1
6	Spring	1
7	Cap Under Plate	1
8	Spring	1
9	Cap Heater	1
10	Cap Heater Cover	1
11	Adjusting Screw	1
12	Transformer	1
13	Solid State Relay	1
14	Limit Switch	1
15	Cap Press Frame	1
16	Shaft	4
17	Front Iron Cover	1

18	Electrical Case	1
19	Back Cover	1
20	GY-04 Digital Controller	1
21	Power Switch	1
22	Power Socket	1
23	Power Cord	1
24	Support Arm	1
25	Connect Piece	2
26	Connect Piece	2
27	Adjusting Screw	1
28	Hand Wheel	1
29	Connect Plate	1
30	Handle Shaft	1
31	Handle Bar Grip	1
32	Cap Heat Platen	1
33	Heat Platen Cover	1
34	Fixing Iron Plate	1